

# Downdraft Rocket Kiln Plans

Lisa Orr, Rodney Morgan, Andrew Linderman, Fernando Aidar

*Updated October 12, 2023*

This is a “living” document and will be updated as the plans are revised.

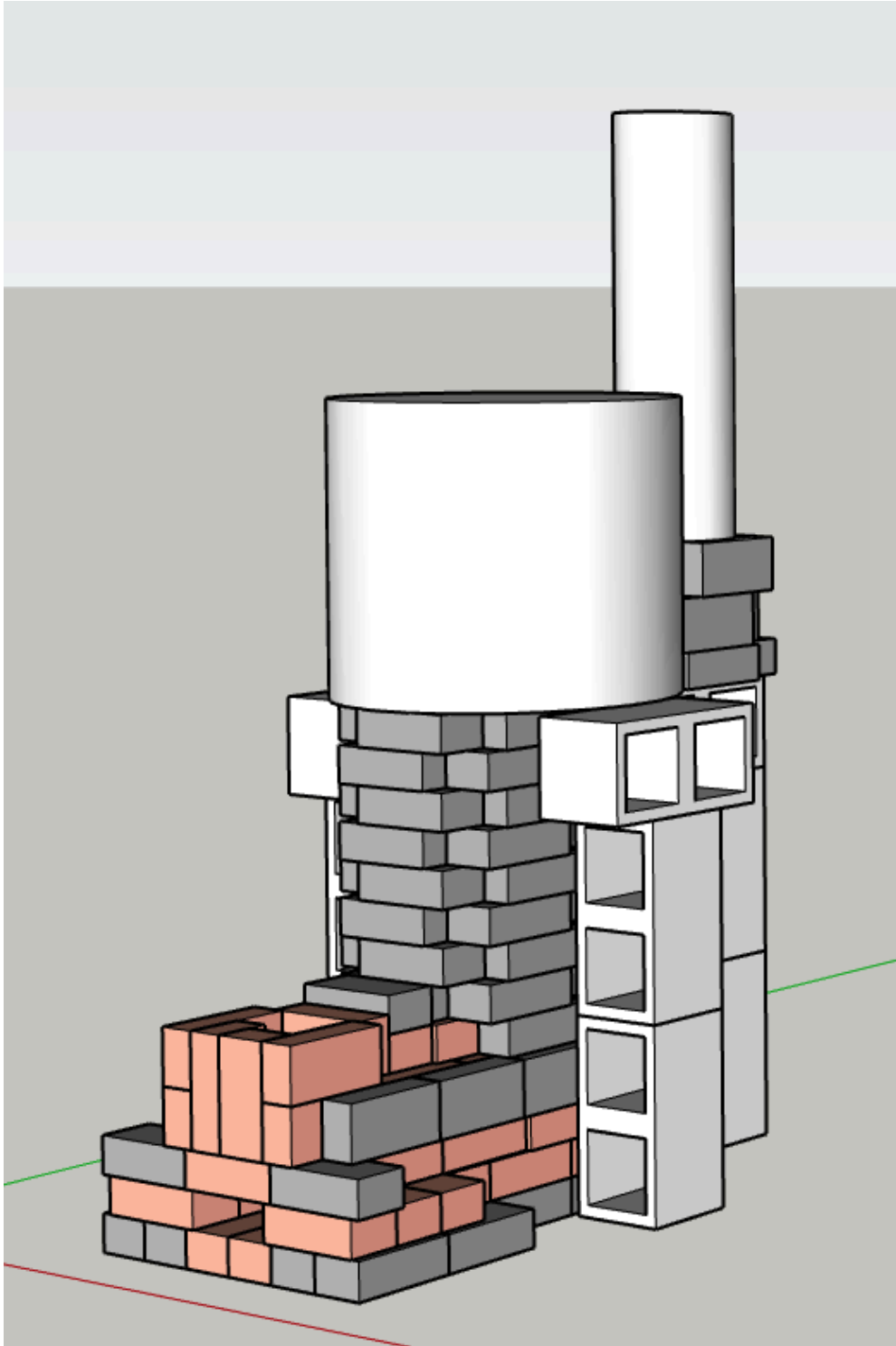

## Materials List

**Hard Brick:** (9x4.5x3") 42 (4 extra for covering the Primary and Secondary Air, and 2-3 for the bag wall) No cuts needed but a soap or

**Soft Brick:** (9x4.5x3") 74

**Concrete Block:** 11 (8"x8"x16" blocks)

**Insulated Stove Pipe Chimney:** 1: 8" int. Diameter. 3' length. We added hardware handles on the side so it was easier to remove at the end of the firing to close the flue. Having an extra foot may be necessary with a taller kiln body or if the draft is not strong enough. Tuning the kiln by changing height of chimney is important depending on the size of the ware chamber.

**Kaowool Blanket:** (Not shown in Sketchup models) about 1'x4' is needed. Additionally, a ~2'x5' roll can be wrapped around the heat riser to reduce cold air inlet and increase insulation (faster firing!).

**Firebox Grate:** a 9x7" piece of kiln shelf with "swiss cheese" holes drilled into it. Ours had ~1" holes in it, but 1/2"-3/4" holes would probably work better.

**Kiln Body:** 1. We used a 1018 kiln body (10 sided kiln with 2 rings). The top should have no holes. The bottom will get a ~7"x7" square hole next to the side wall. The back of the body will also get a ~7"x7" hole. Important to worm band the kiln for structure. Also wormband the top and bottom rings.

**Kiln Shelves:** 4-6: a variety of old kiln shelves have worked great for us. We used some small pieces to shim around the concrete block supports, made one into a grate, used 3-4 inside the kiln, and 1 to close the flue at the end of the firing.

**Kiln Furniture:** we used regular stilts from an electric kiln. They worked well.

**Worm Band:** 1-2 35' Packages. This wrapped around various parts of the kiln to hold the bricks together.

[https://www.amazon.com/STEELSOFT-Assortment-Fasteners-Stainless-Adjustable/dp/B08Y6LKW5F/ref=asc\\_df\\_B08Y6LKW5F/?tag=hyprod-20&linkCode=df0&hvadid=507467648565&hvpos=&hvnetw=g&hvrnd=4126750598964101978&hvpon=&hvptwo=&hvqmt=&hvdev=c&hvdvcmdl=&hvlocint=&hvlocphy=9001812&hvtargid=pla-1266000177756&th=1](https://www.amazon.com/STEELSOFT-Assortment-Fasteners-Stainless-Adjustable/dp/B08Y6LKW5F/ref=asc_df_B08Y6LKW5F/?tag=hyprod-20&linkCode=df0&hvadid=507467648565&hvpos=&hvnetw=g&hvrnd=4126750598964101978&hvpon=&hvptwo=&hvqmt=&hvdev=c&hvdvcmdl=&hvlocint=&hvlocphy=9001812&hvtargid=pla-1266000177756&th=1)

**Kiln Wash:** Not necessary unless you are spraying soda. We used an 85:15 mixture of silica:kaolin and BRUSHED it on.

**Notes on insulation:** Having as much of the kiln insulated as possible is ideal. The heat riser needs to be soft brick. Some of the soft brick around the base of the kiln could be replaced with Kaowool, a cobb/perlite mixture, or combination of the two. Mudding up cracks in the kiln with a refractory clay slurry or castable is helpful to prevent drafts.

<https://ceramicartsnetwork.org/ceramic-recipes/recipe/Castable-Refractory-168843#>

## Just some items to be thought about

1. K26 is a good soft brick. The K23 is a little too soft if you are buying the brick. Any suggestions/preference. 2600degF or 3000degF brick.
2. High-Temp Fiberboard and Kaowool are great options to increase insulation in hard to reach areas of the kiln, or if you don't have access to a brick saw

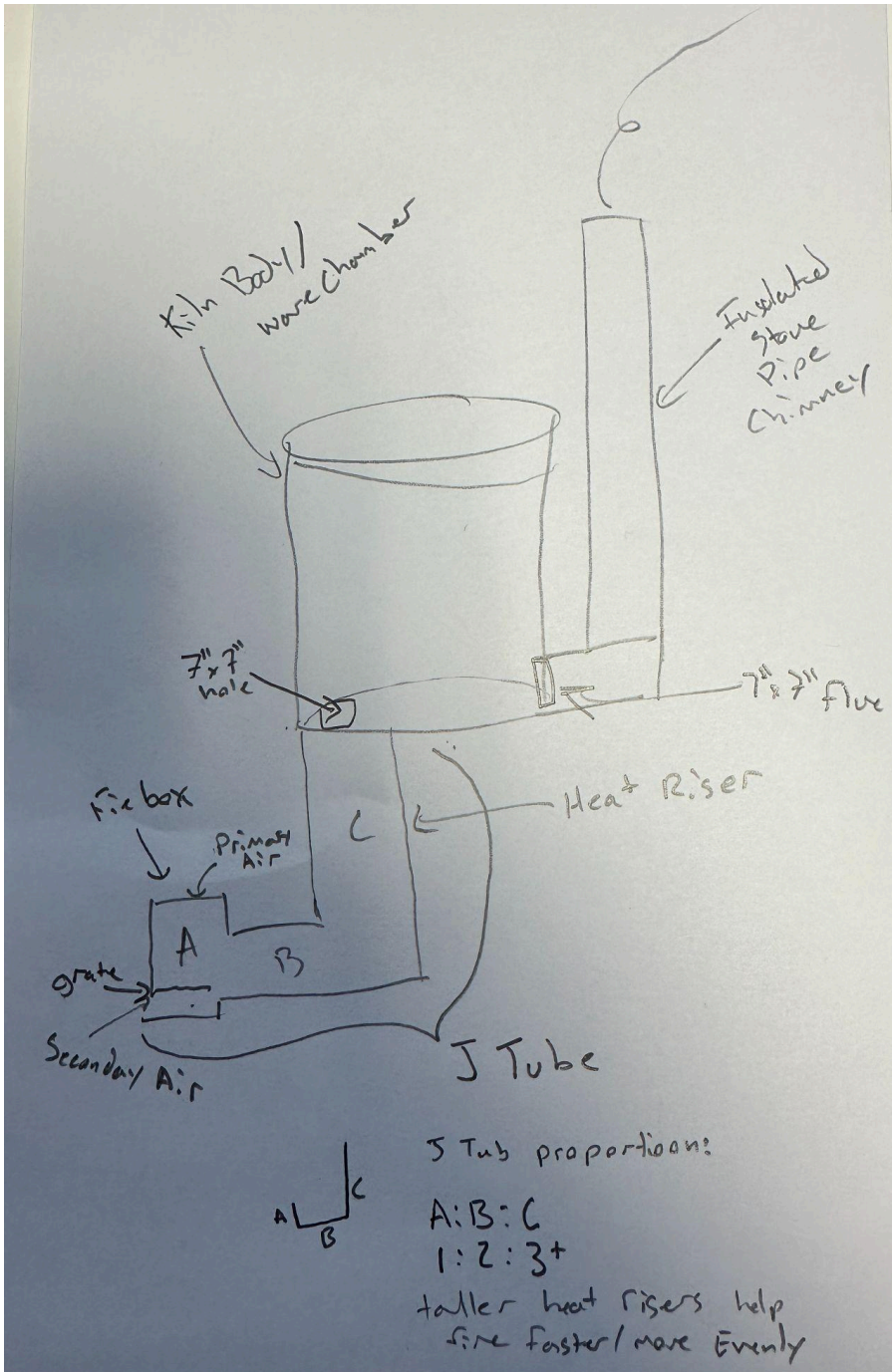

This diagram shows the rough layout and proportions of the parts of the rocket kiln. The proportions of the J tube, heat riser and flue openings are important for the efficient firing of a rocket kiln. This is designed to fire in neutral/oxidation.

An 8" insulated/double wall stove pipe has a cross-sectional area roughly equivalent to a 7" x 7" square opening. If you are building this from recycled brick/materials, maintaining a ~50 sq.in. area throughout the J Tube.

J Tube Proportions:

A:B:C

1:2:3+

A taller heat riser has been helpful for fast, even firing.

## Layer-by-Layer Plans

### LAYER 1

Grey: Soft Brick    Peach: Hard Brick

Make sure you have a level area to construct the kiln. Packed gravel works well, if you don't have a concrete/asphalt/paved surface.

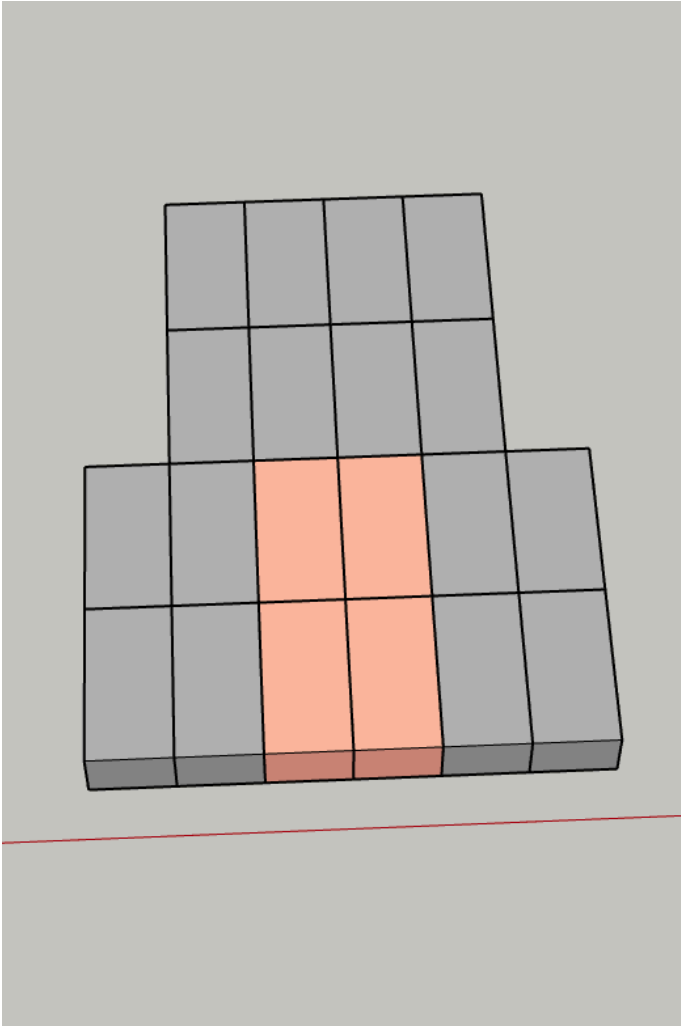

The hard bricks will be located underneath the firebox/grate.

The footprint of the J tube measures 27" by 36".





### LAYER 3

Grey: Soft Brick    Peach: Hard Brick

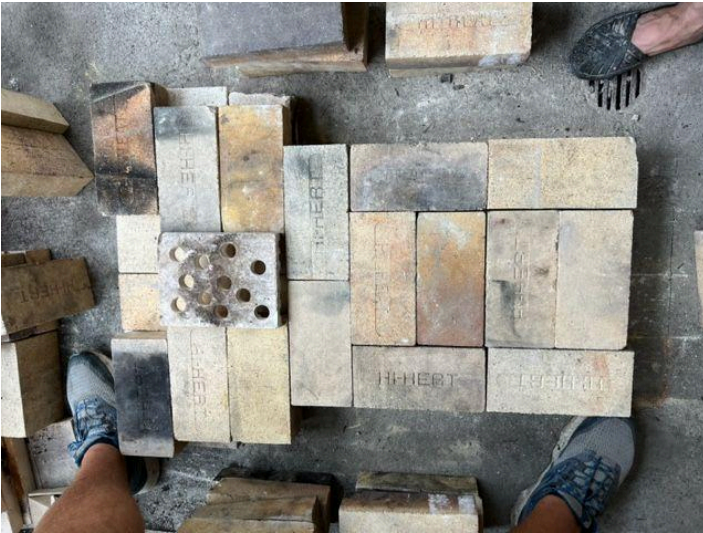

The “Swiss Cheese” Grate measures 9x7'. In the picture, you see 1” holes, more, smaller ( $\frac{1}{2}$ - $\frac{3}{4}$ ”) holes would work better.

There were also air channels cut into the underside pointing farther in the J tube.

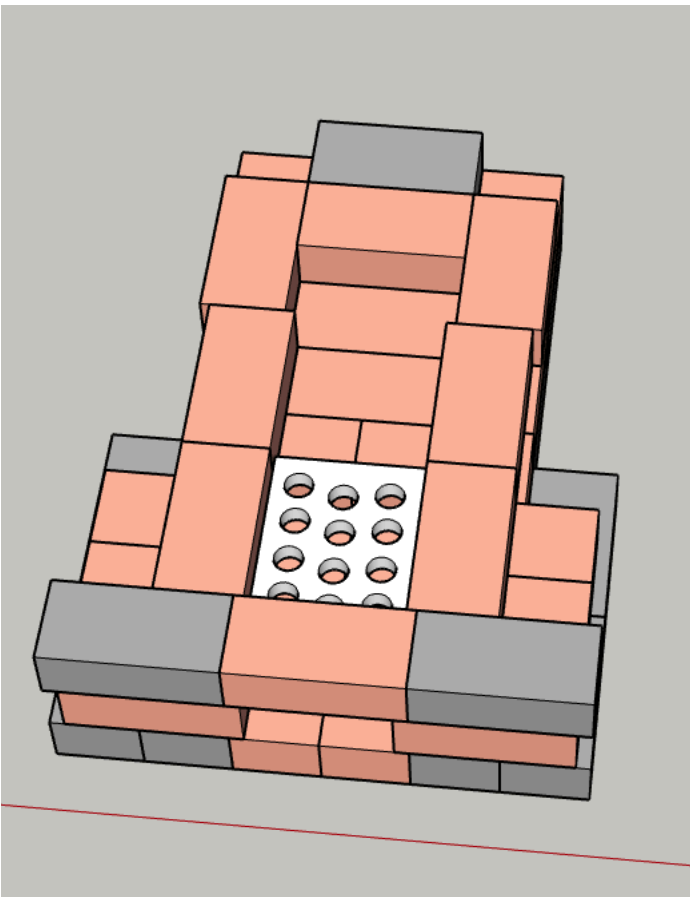

The grate should fit snug left to right. Make sure some air can move between the grate and J tube.

The secondary air opening (under the grate, in front) should be as wide as possible. You will add a hard brick to “seal” and adjust air flow in Layer 14.

## LAYER 4

Grey: Soft Brick    Peach: Hard Brick

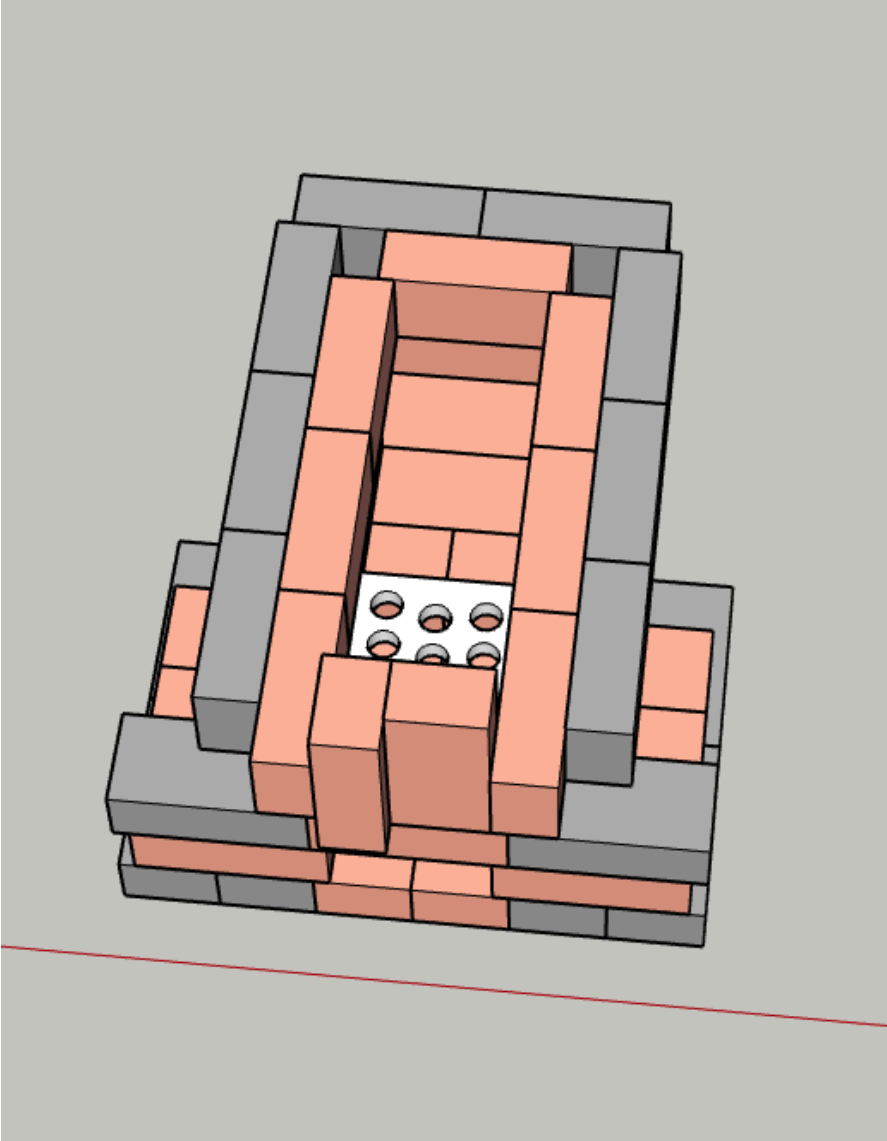

The void space in the back corners (bottom of heat riser), should be filled with kaowool or an insulating cobb/castable. If you have extra soft bricks you can cut some to fill in the spaces.

The vertical bricks in the front of the firebox could be cut to fit. We wanted to make plans that excluded any hard brick cutting, but if you have a soap brick, that could be used instead. Soft brick should not be used in the firebox or anywhere that has wood/brick sliding past one another.

This entire layer should have a worm band wrapped around it to keep everything snug and reduce airflow. If you plan to cover the entire bottom section/J tube with insulating castable, you could skip this worm band.

## LAYER 5

Grey: Soft Brick    Peach: Hard Brick

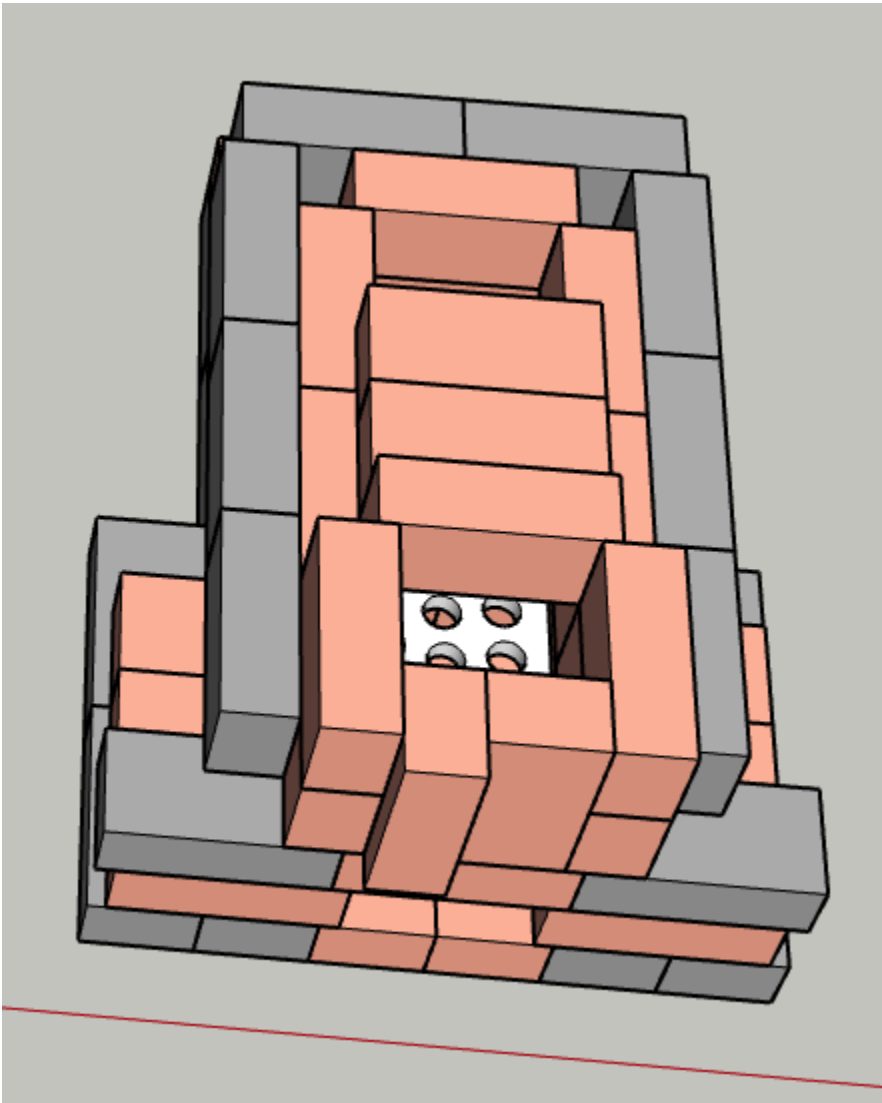

The top Layer of the firebox should be wrapped with a worm band to add strength to the upright bricks. When stoking, the wood will lean against the top edges and can force the bricks to separate if they are not braced. See below picture of worm banded firebox in use.

The 2 hard bricks covering the bottom of the J-Tube could be substituted with soft brick if you have extra soft brick.

As you can see in the right picture, we layed kaowool over this section to increase the insulation.





## LAYER 6

Grey: Soft Brick Peach: Hard Brick

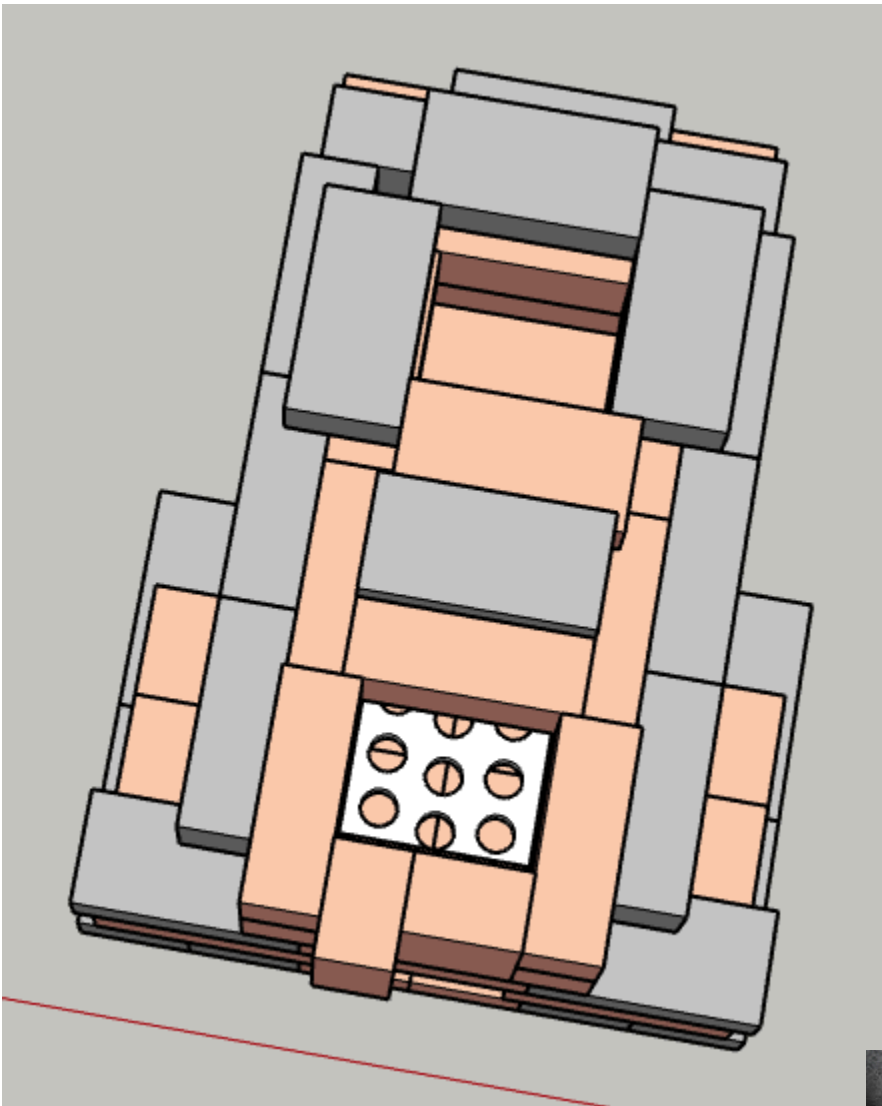

Here is an aerial view and side view of the added soft bricks to start the heat riser. The soft brick on top of the bottom of the J tube can be replaced with kaowool or insulating castable/cobb.

Please note how the bricks starting the heat riser are offset counter clockwise (below). They will alternate (see layer 7-9) as you build the heat riser taller.

If you have access to a brick saw, or masonry hacksaw blade for soft brick, you can notch the corners for a better/tighter fit.

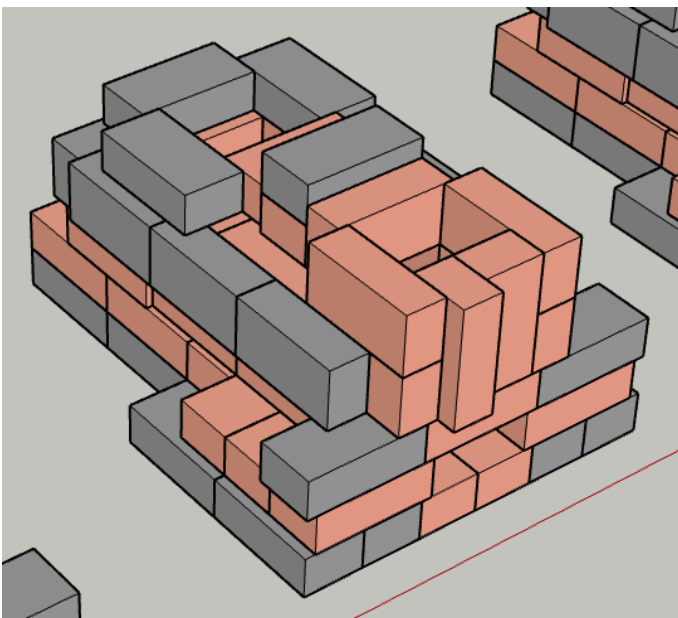

## LAYER 7

Grey: Soft Brick    Peach: Hard Brick

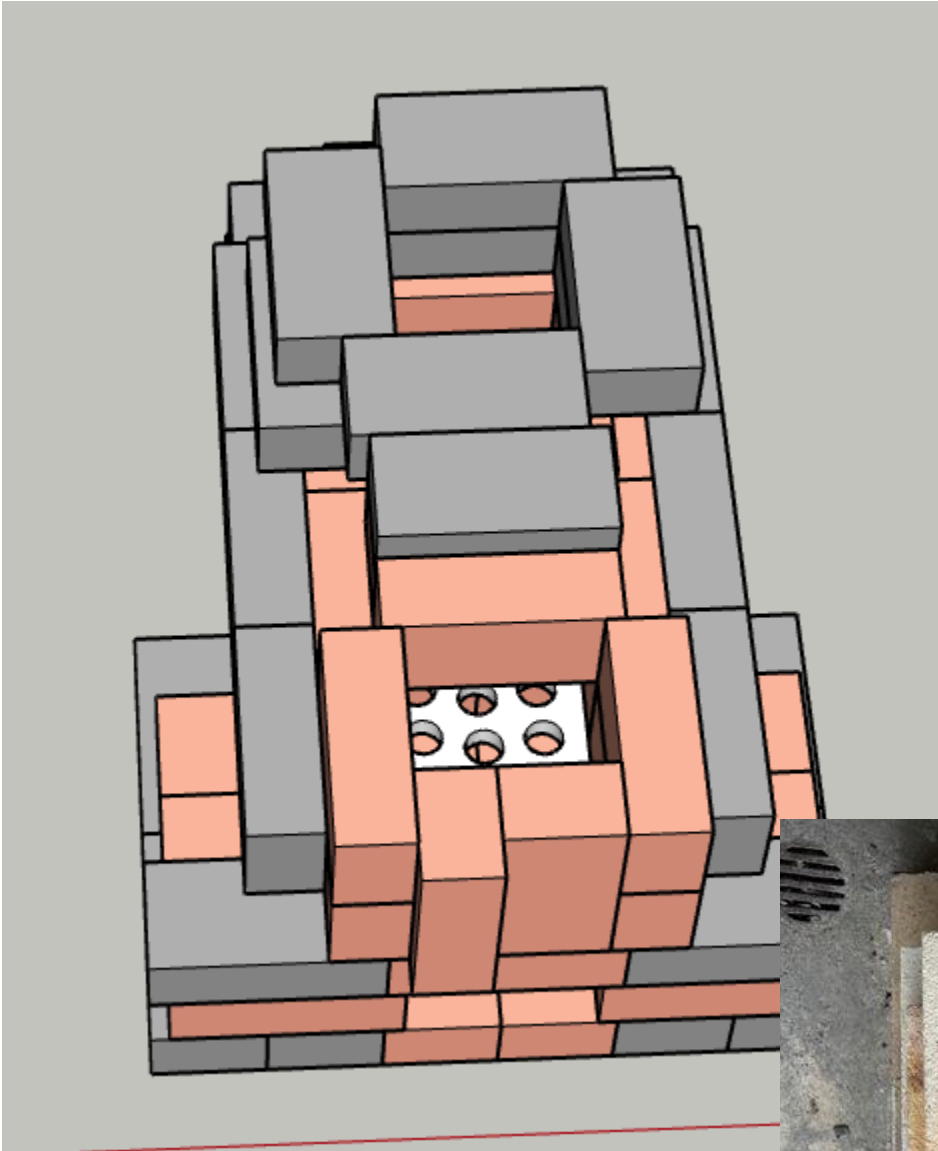

The second layer of the heat riser.

Alternate the brick offsets to maintain a square opening of approximately 7"x7".



**LAYER 8**

Grey: Soft Brick    Peach: Hard Brick

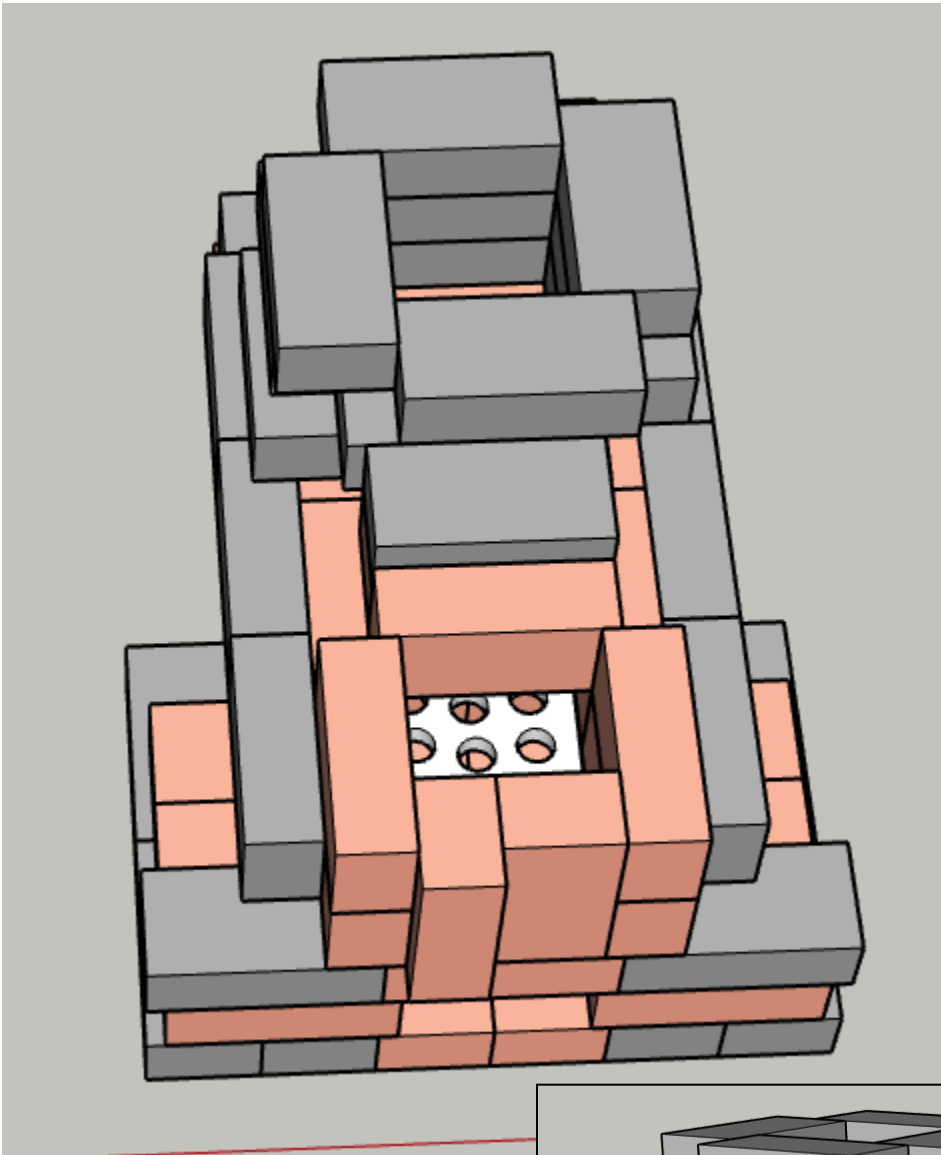

The third layer of the heat riser. This offset should be similar to the bricks to layers down (Layer 6).

Here is an aerial and side view.

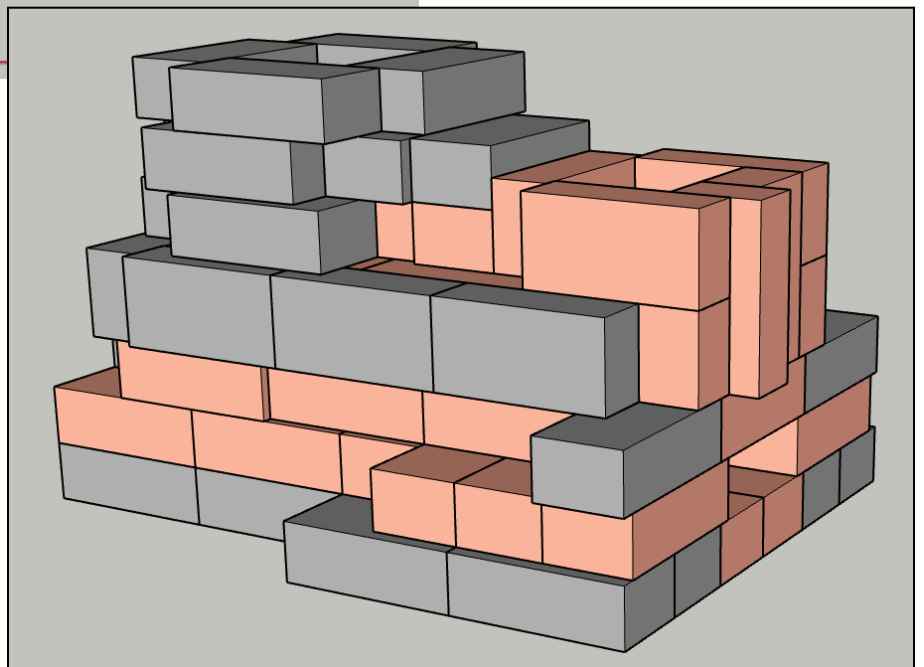

## LAYER 9

Grey: Soft Brick    Peach: Hard Brick

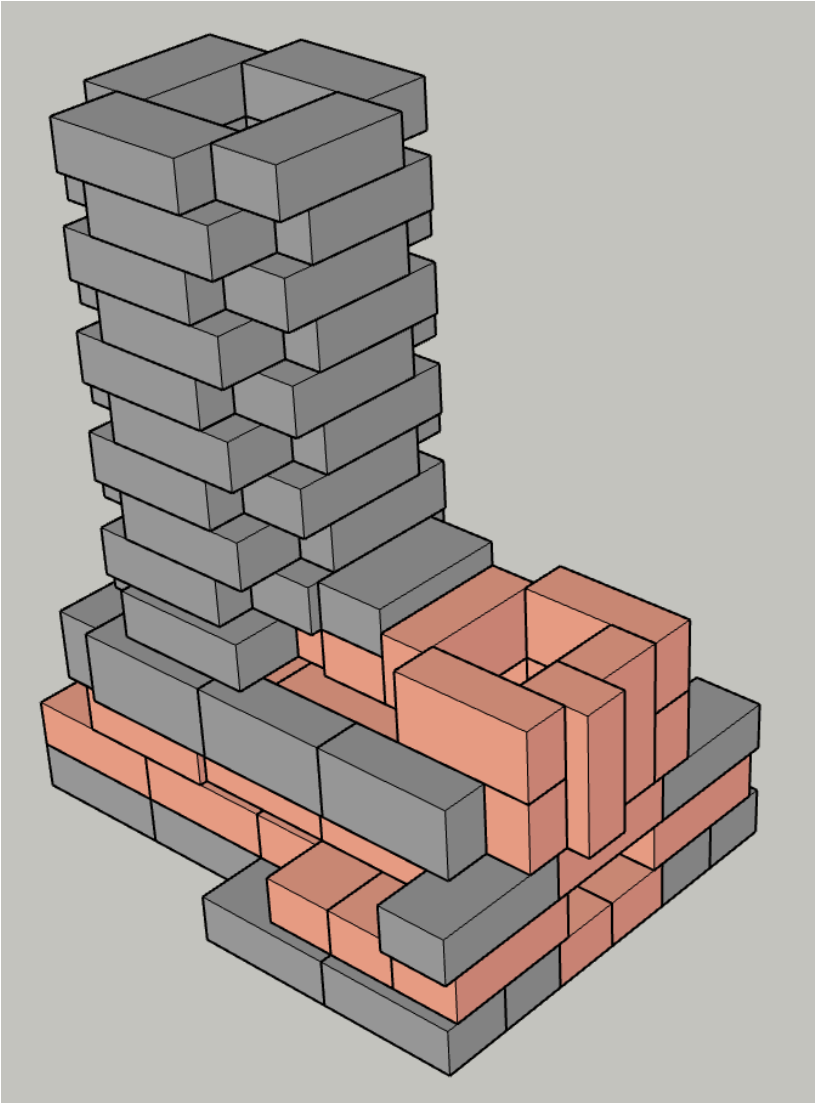

In this step you will finish building the heat riser. In this model, the heat riser has 10 total soft brick layers.

If you are using different dimensioned bricks, you may need more (or fewer) layers.

The height from the bottom of the J tube (measured internally) to the top of the heat riser should be about 32". We have made kilns with shorter heat risers, but they burn less efficiently and fire less evenly.





## LAYER 10

Grey: Soft Brick Peach: Hard Brick

This step adds the concrete block supports for the kiln body and the chimney.

You may want to wrap the entire heat riser with a 2'x5' kaowool blanket before placing supports. You will need shims and a kaowool gasket around the heateriser before placing the kiln body (Page 13-14)

You may want to use a large shelf piece to help support the 4 chimney bricks (bottom left).

The footprint of the kiln, with the concrete block supports is about 3' x 5'.

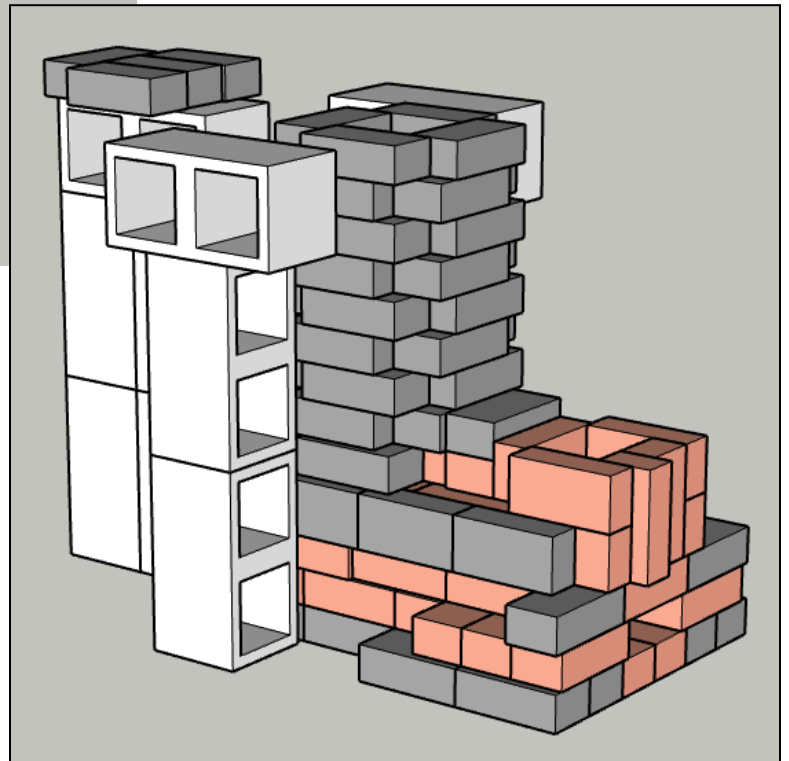
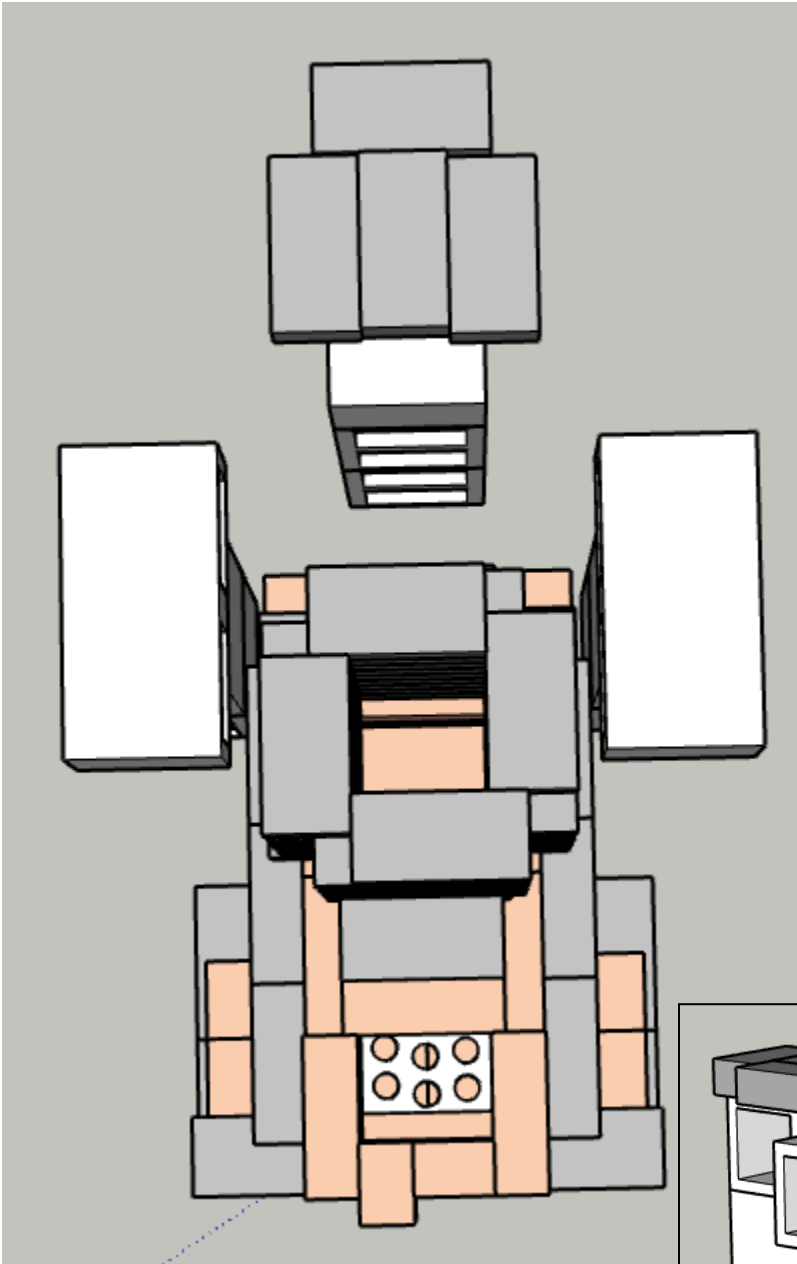



## Adding Shims and Placing the Floor of the Kiln



Using pieces of kiln shelf, some split bricks and kaowool, we shimmed the supports to place the kiln bottom.

Kaowool is used around the heat riser to form a gasket. If you are using refractory cobb/castable, this would be a good place to add some around the kaowool.

Be sure the kiln floor is level and sturdy. The area where posts will sit should ideally have support under them.





## Cutting the Heat Riser Hole in the Kiln Bottom



You can place tape upside down around the heat riser opening and set the kiln lid on it to determine where to cut. A cardboard template cut to ~7"x7" and set about 3" in from the edge of the bottom would also work. We cut the brick with a jigsaw and old blade after drilling holes in each corner.

We selected an already crumbling section of the kiln floor to place our cut. We suggest lining it up with one of the "flat" sides.

Consider adding a worm band around the bottom of the kiln to reinforce the bottom strapping. We have experienced that many of these initially fail during firing.





## Cutting the Flue into the Kiln Side



A 7"x7" hole should be cut in one of the sides of the bottom most section of the kiln body. You may need an angle grinder or dremel to cut through the metal of the kiln. Leave a strip of the metal intact on the top and bottom of the hole. Any places with crumbled brick were filled in with Kaowool.

In the below image you can see how the heat riser and flue openings are opposite of each other.

You can also see a green string in the bottom picture. We built this kiln under an awning and used the string as a plumb bob to determine where to put our chimney.



## LAYER 11

Grey: Soft Brick    Peach: Hard Brick

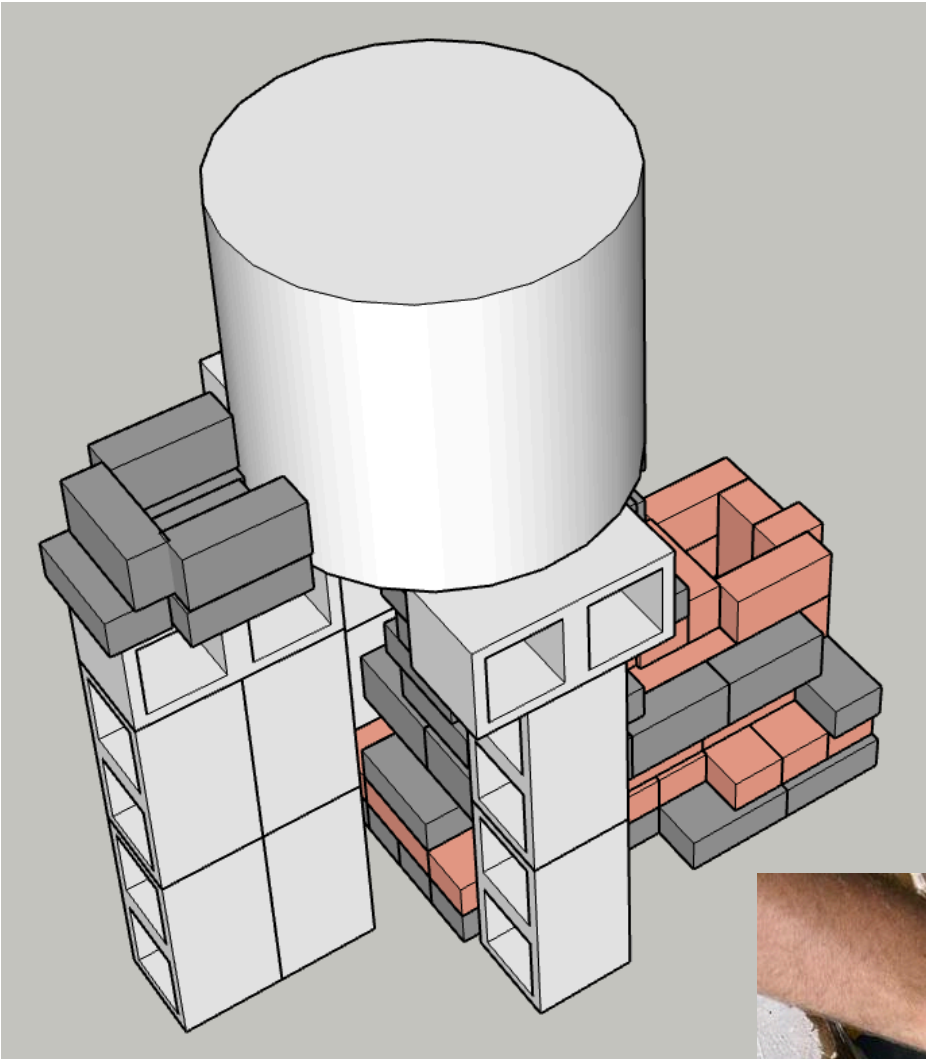

When placing the chimney bricks, snug them up against the kiln body as best as possible and add worm band around the entire kiln and bricks to hold them in place.

We added kaowool into the nooks where the bricks meet the kiln. If you have a masonry hacksaw blade, you can cut tapers into the soft bricks so that they meet more snugly.





## LAYER 12

Grey: Soft Brick    Peach: Hard Brick

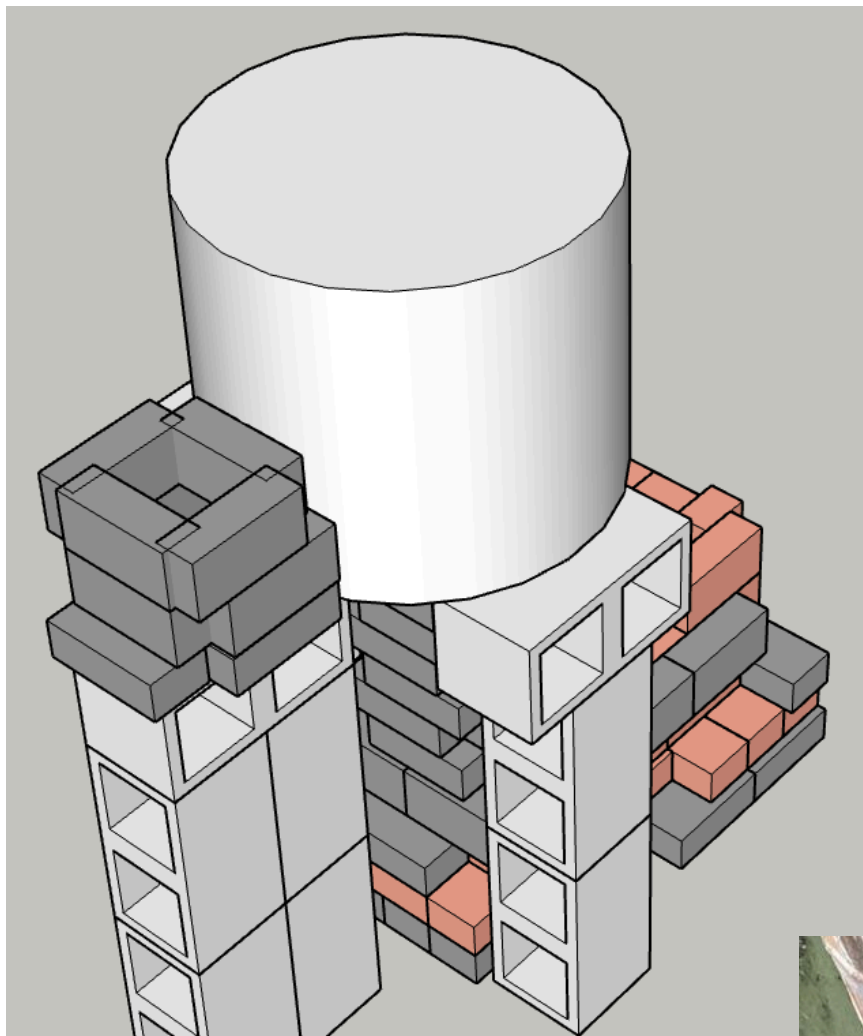

This layer of soft brick requires some notches to be cut and a brick shortened. Again, the hole should be about 7"x7". The chimney will sit on top of this layer. We added and 1' square of kaowool between this layer and the kiln to create a nice seal before adding the stove pipe.

This layer needs to be worm banded around the entire kiln again.

If you are trying to fire in reduction damper could be added above this level.

Having flame in the stove pipe (it will glow) is inefficient and will damage the stove pipe. Adjust this by stoking lighter and opening the primary and secondary air ports.





## Add the Chimney

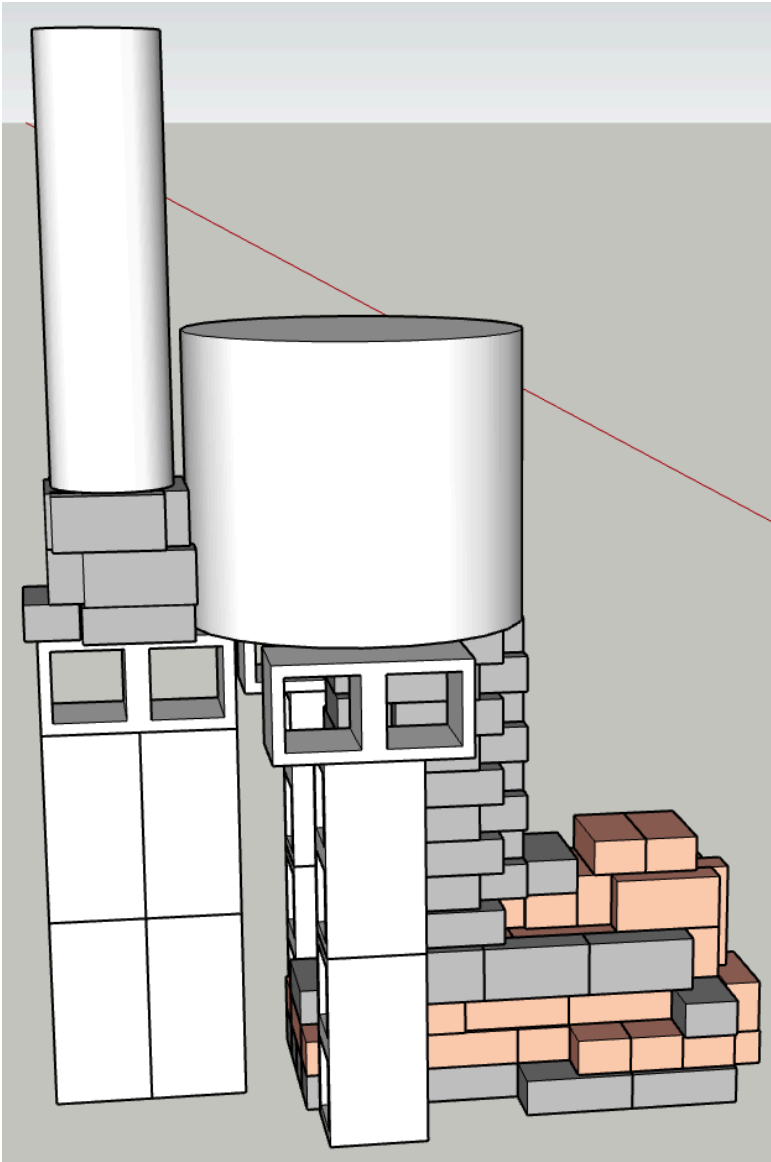

Here you can see the added 8" insulated stove pipe. We were able to fire to cone 10 in 3 hours with a 3' stove pipe. If you have a larger kiln body a 4' pipe or added brick layers may be necessary. This chimney could also be constructed from soft brick as the insulation increases the draw.

The picture at the right shows the additional handles that were screwed into the stove pipe. We added these to make it easier to lift the stove pipe and cap the flue at the end of the firing. The stove pipe will be **EXTREMELY HOT!!!** We used kaowool pads underneath welding gloves to lift the stove pipe.

## Adjusting the Air and Stoking the Kiln

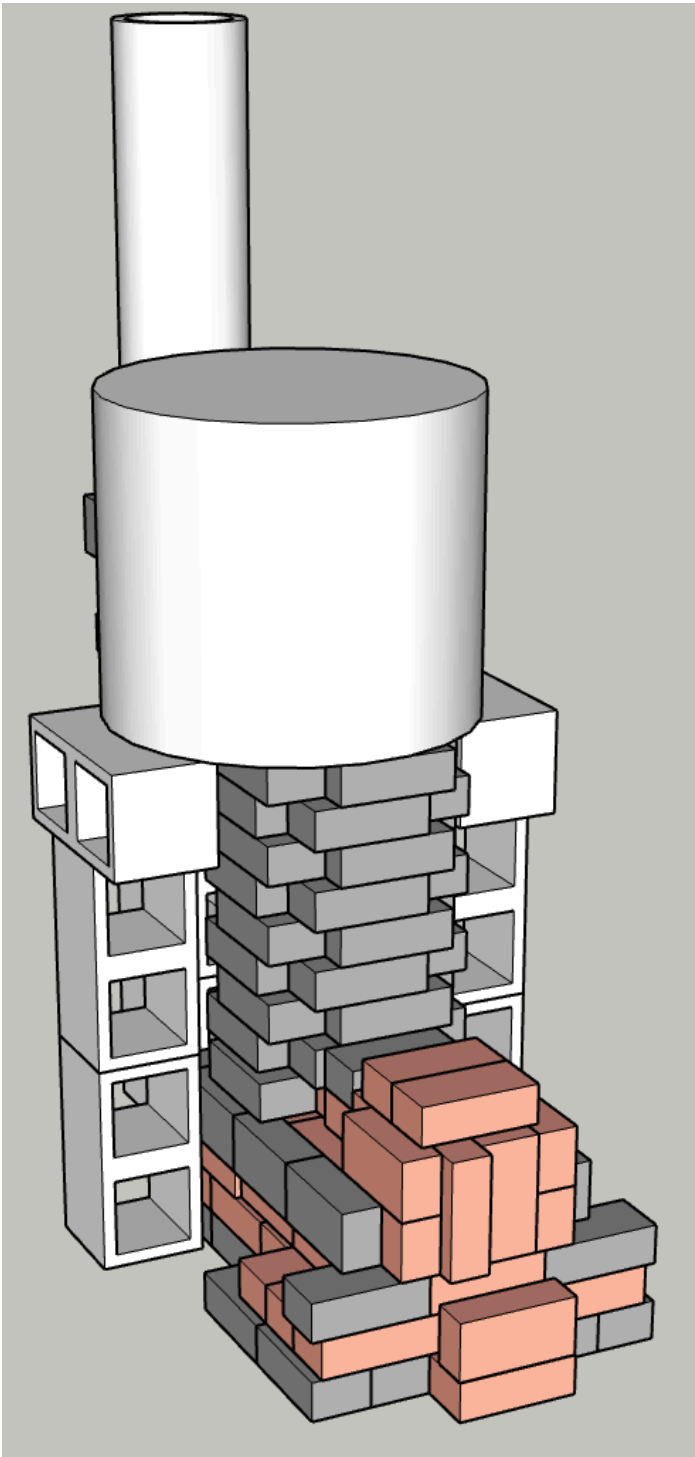

Hard bricks are placed over the firebox opening and the fuel (the skinnier the better) is fed in from the top. This creates a “self-feeding” fire that burns from the bottom up.

There are also two hard bricks in front of the secondary air (cleanout port). The bottom one is just a riser. The second one should be adjusted to keep the kiln firing efficiently. If you’re used to firing kilns with dampers, this will act similarly in that it will help you keep the kiln in or out of reduction. I will state again, that if flame is **IN THE CHIMNEY**, the stove pipe will superheat and glow, this is bad for the chimney pipe and means you are stoking too heavily or not enough primary/secondary air is coming into the rocket kiln. Firing in a neutral/efficient manner may require you to change how you think about firing a wood or gas kiln, as this kiln is designed to maximize efficiency, not atmospheric effects.

We have fired these kilns with sprayed soda to create some nice flashing effects. Using one of the peep hole ports or pyrometer ports worked well. This is an area we would like to explore more and adjustments inside the ware chamber and to the bag wall may be required.